

Installation Guide

Contents

Prior to installation	2
Symbols used in the installation guide	2
Safety instructions	3
Installation instructions	4
Connection diagram for the navigation system	5
Installation of the GPS antenna	6
Installation of the microphone	9
Connection of the reverse signal	12
Connection of the speed signal (GAL) from the speedometer/ tachometer	13
Installation/ Removal of the Traffic Pro.	16
Commissioning and calibration	17
Service mode	20
Connections	24

Prior to installation

Before starting installation, please read this installation guide carefully. In particular, please pay attention to the safety and installation instructions.

Symbols used in the installation guide



denotes instructions which are important for your safety and the safety of others.



denotes instructions which are important for the installation and function of the unit.

Safety instructions



Incorrect installation

Incorrect installation may result in damage to the unit or to the vehicle. Specialist knowledge and skills are required to install the unit and its components. We strongly recommend that you have the unit installed by a specialist workshop.



Risk of injury

Installing the components incorrectly may lead to injuries in the event of a road traffic accident or render safety devices ineffective. Please refer to the instructions provided by the vehicle manufacturer.



Damage to the airbag

Installing the components in the wrong location may damage the airbag or impair its operation. Do not install the components within the operating range of the airbag.



Risk of injury due to loose connection

Connect the components so that they cannot come loose in the event of a collision or sudden braking.

Installation Guide

Installation instructions



Damage due to polarity reversal or short-circuit
Incorrect cable connections and short-circuits can seriously damage the unit.
Disconnect the vehicle battery before installing the unit.



In order to avoid short-circuits and malfunctions, install the cables so that they cannot be pinched, kinked, chafed or detached.



Before installation, park the vehicle in a safe and level place and remove the ignition key.



In order to avoid malfunctions, it is absolutely essential to observe the relevant cable cross-section when using branch connections/cable connectors.



In order to avoid short-circuits and any associated risk of fire, cables which have to be cut must be properly insulated.

Connection diagram for the navigation system

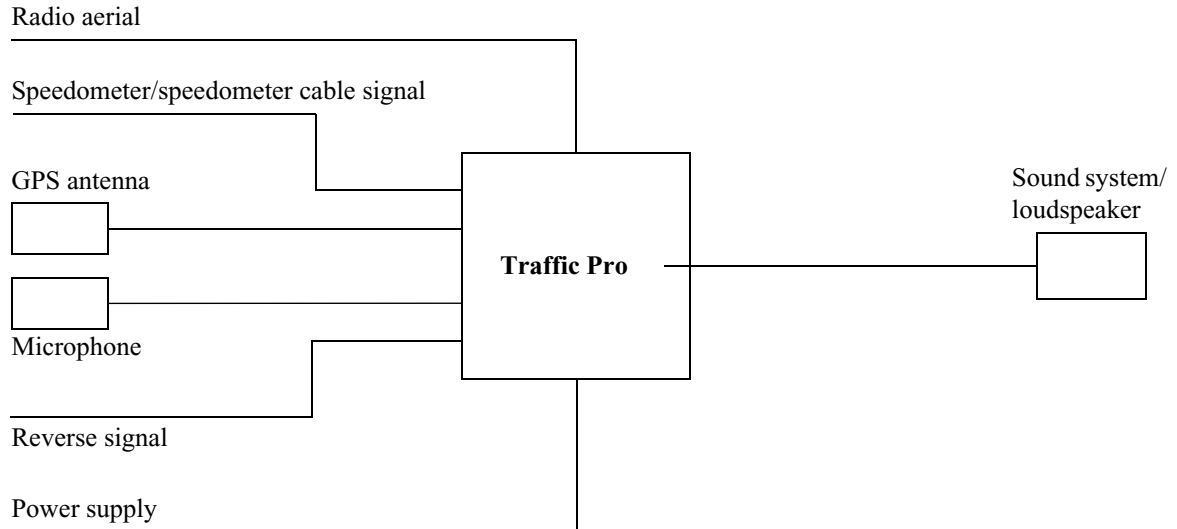

Note: Connection options are described in detail on Page 24.

Installation Guide

Installation of the GPS antenna



Risk of injury

People with pacemakers should avoid proximity to the magnetic antenna and should not carry the antenna on their person, as this may affect the function of the pacemaker.

Keep the magnetic antenna away from data storage media (disks, credit cards, magnetic cards etc.) and electronic and precision engineering equipment, as this may cause data to be deleted.

Do not use the antenna in areas at risk of explosion.

The antenna is to be affixed in such a manner that it cannot detach in the event of a collision or sudden braking.

Possible installation positions

- **Outside the vehicle**
 - a. Attach the antenna to a flat, pre-washed metal surface.
 - b. Then guide the antenna cable into the vehicle interior.



Risk of injury

The maximum vehicle speed for the antenna if magnetically attached is 180 km/h. The antenna must be removed or specially secured at higher speeds.

The antenna is not suitable for car-wash facilities.

- **Inside the vehicle**



The GPS antenna is not suitable for installation in vehicles with anti-glare windows (metalised thermo-glass or metal foil (can be seen on the window label - SIGLA SOL, SIGLA CHROM, SIGLA, KOOL-OF, SUNGATE, etc.) and vehicles with fine-meshed heating wires in the windows.



Information on installation position

When selecting the installation position, ensure that the antenna has a clear view in all directions, and that it is not covered by the windscreen wipers. Obstructions caused by the bonnet, window crossbeams and roof should be avoided as far as possible.

Concealed installation beneath the vehicle console is not permitted.

Installation on the vehicle side windows is not permissible.

The antenna cable should not run parallel to other cables in the vehicle.

The antenna cable should be routed via the shortest distance from the navigation system to the antenna. The excess cable should be attached directly below the antenna.

Installation Guide

- a. Secure the antenna to the base plate (1) with magnets.
- b. Remove protective strip from top of adhesive tape (2) and stick to the centre of the base plate underside.
- c. Remove protective strip from bottom of adhesive tape (2) and stick the antenna and base plate onto the vehicle console beneath the windscreen at the installation position.

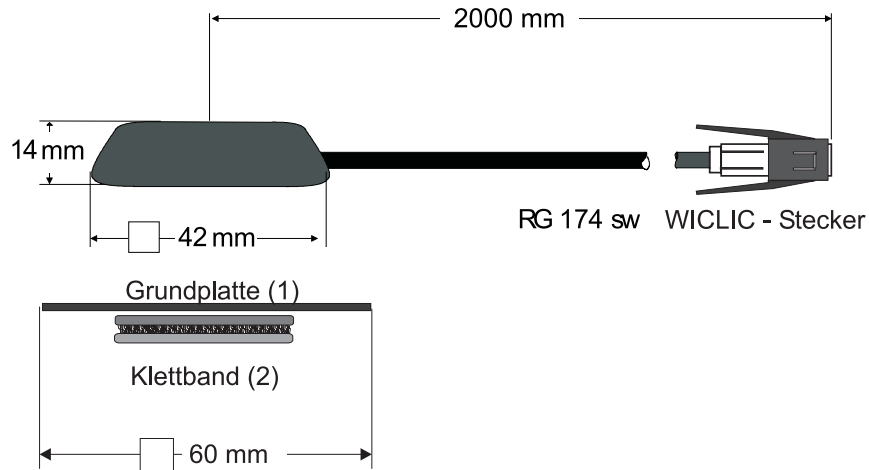

Installation of the microphone

The microphone should be placed in the vehicle to allow optimal recognition of the speaker's voice. Possible positions in the vehicle for the microphone can be seen in the following diagram.



The installation position should be as far away from the loudspeakers, and as near to the speaker, as possible. If problems occur, different positions should be tested. In order to pick up as little background noise as possible, the microphone has a narrow pick-up angle and must consequently be directed towards the driver.



- A*: Optimal installation position
- B*: Alternative installation position
- C*: Speaking direction on microphone
- D*: Adhesive strip for affixing to smooth surfaces
- E*: Screw for fastening the screw-on plate
- F*: Screw-on plate for affixing to rough or uneven surfaces.

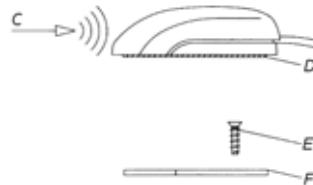

Affixing the hands-free microphone to a flat and smooth surface can be accomplished with the adhesive strip *D* (Clean adhesion surfaces).

Installation Guide

If the microphone is to be affixed to a rough or uneven surface, the screw-on plate *F* should be affixed first with the screw *E*. (To avoid risk of damage to any cables installed underneath or other vehicle components, please pay attention to screw length.)

Subsequently, affix the microphone to the screw-on plate *F* with the adhesive strip *D*. The connection of the hands-free microphones takes place in socket C of the Traffic Pro.



In order to avoid short-circuits and malfunctions, install the cables so that they cannot be pinched, kinked, chafed or detached.

Connecting a microphone to the Traffic Pro

a. Connection without CD changer

For connection of the microphone to a Traffic Pro **without CD changer**, the enclosed blue socket must be connected as described below. Before connection, remove protective cap *A* from both contacts.

b. Connection with CD changer

For connection of the microphone to a Traffic Pro **with CD changer**, the enclosed blue socket must be connected with the two leads as described below. Before connection, remove protective cap *A* from both contacts.



Caution!

Once the contacts have been inserted into the blue plug housing, a special tool is required to remove them.

Connection of the blue plug housing

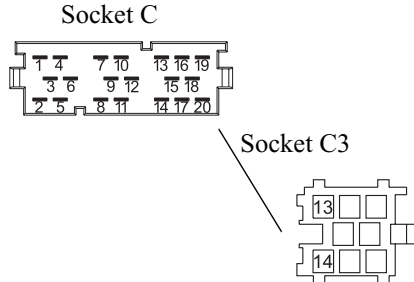

Pin	Colour	Function
13	white	NF
14	yellow	Earth

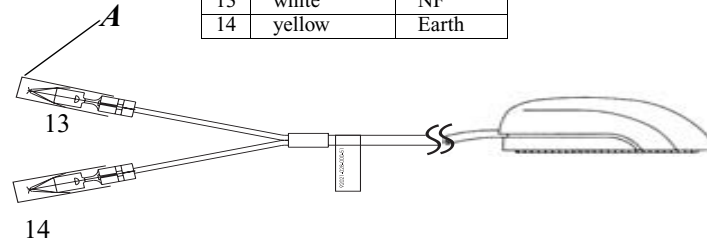

Installation Guide

Connection of the reverse signal



Pick-up points for the reverse signal vary from vehicle to vehicle.

If you are in any doubt, please contact your vehicle manufacturer or authorised specialist workshop.

If the switch on the gearbox or shift linkage is accessible:

- Connect a separate lead to the activated contact.

Connect lead to socket A, pin 2.

Low - level = earth, high - level 12 V - 16 V

If the switch is not accessible:

- Check which lead is routed to the reversing lamp. Then, if necessary, remove the inner cover for the reversing lamp.

Connect a separate lead to the activated lead of the reversing lamp and connect to socket A pin 2.

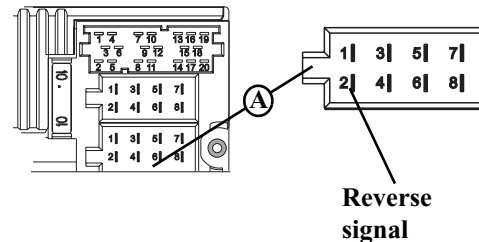

Connection of the speed signal (GAL) from the speedometer/ tachometer



Accident hazard

Incorrectly connected wiring may result in damage to or destruction of vehicle components and safety devices. If you are in any doubt, please contact your vehicle manufacturer or authorised specialist workshop.

Electronic speedometer

- Remove the signal from the speedometer, extend and connect to socket A pin 1.



Depending on the vehicle equipment, the lead for the GAL signal is usually connected to the DIN - ISO plug of the car radio. The assignment of the DIN - ISO plug may vary depending on the vehicle type.

- Minimum requirement for the signal:
0 Hz - 4 kHz/square-wave signal (no inductive sensor)
Low level < 1.5 V, High level 5 V - 16 V



If you do not know the exact installation position/location of the speed signal, please consult the vehicle manufacturer.

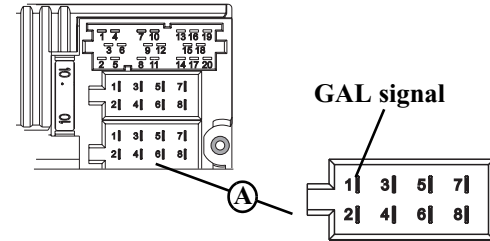

Installation Guide

Mechanical speedometer with built-in speed sensor in the speedometer cable

- Remove the signal from the speed sensor, extend and connect to socket A pin 1.
- Minimum requirement for the signal:
0 Hz - 4 kHz/square-wave signal (no inductive sensor)
Low level < 1.5 V, High level 5 V - 16 V

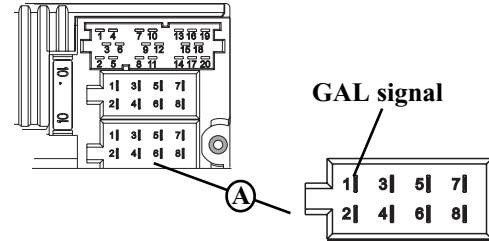

If you do not know the exact installation position/location of the speed signal, please consult the vehicle manufacturer.

Mechanical speedometer without speed sensor in the speedometer cable

A speed sensor must be built into the speedometer cable to generate a digital signal.

The VDO Adapter 2152.30300000 or a vehicle-specific adapter that fulfils the minimum requirements can be used. The VDO speed sensor is suitable for direct installation on the gearbox (no further installation parts required) or in the speedometer cable (in conjunction with additional universal installation parts).



If the sealed speedometer cable is released, a correct display cannot be guaranteed. Incorrect installation leads to improper functioning of the navigation system or of the speedometer.

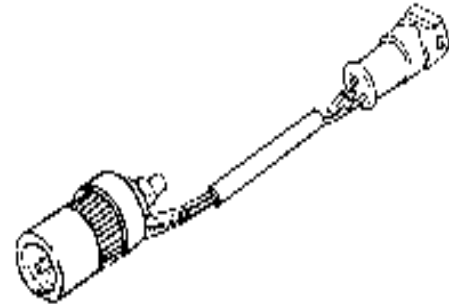

Installing the speed sensor directly on the gearbox

- Release the speedometer cable and screw speed sensor onto gearbox. Screw released speedometer cable onto the speed sensor and connect the wires.

Cable connections for the speed sensor

- Brown - earth (terminal 31)
- Black - power supply (terminal 15), 9 - 16V, 30 mA
- Blue/red - signal for socket A pin 1

Installing the speed sensor in the speedometer cable

In this case, please contact your dealer or VDO representative.

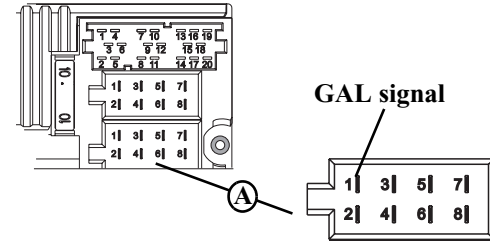

Installation Guide

Installation/ Removal of the Traffic Pro

- Installation:
The Traffic Pro features an integrated universal bracket for DIN installation slots. An installation frame is not required. The Traffic Pro is inserted into the installation slot and secured with the slides supplied.
To install, complete all electrical connections. Remove the control panel. Then push the Traffic Pro into the installation slot. Subsequently, insert slides into the openings on the front of the Traffic Pro as far as the first detent position (Fig. A). Now lock the radio in by pulling on both slides as shown in Fig. B. Subsequently, remove the slides.



The installation angle of the Traffic Pro must not exceed 0° - 35° (vertical).

- Removal:
To remove the Traffic Pro, it must first be unlocked. To do this, remove the control panel and push in both slides as far as the second detent position as shown in Figure A. Then take hold of the Traffic Pro on both sides and pull it out (Fig. C). Next, remove the slides by pressing the springs on the right and left sides of the Traffic Pro.
If the Traffic Pro was previously installed in another vehicle, it may be necessary to adjust the springs on the unit before installation Traffic Pro. To adjust the springs, insert slide as shown in Fig. D and subsequently adjust as shown in Fig. E (Gently press slide in the direction of 1 while at the same time moving the slide in the direction of 2).

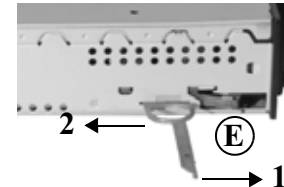
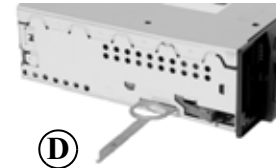
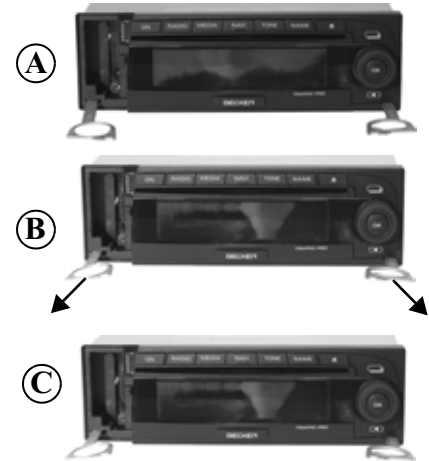

Commissioning and calibration

- For commissioning and calibration, you must switch on the vehicle ignition. Switch on the Traffic Pro and enter the code (see the operation guide for a detailed description).
The vehicle must be parked outdoors, ensuring that it has a clear view in all directions (not in the immediate vicinity of buildings).
- Press **NAVI**.
Navigation is activated.
- If the navigation CD has not yet been inserted, you will be prompted to insert it.
- “German”, the Traffic Pro default language, is loaded.
Following loading, you can select a different language as described in the operation guide.
- The adjacent display appears after the language installation.
You must now wait for sufficient GPS reception.
This procedure (first reception of the necessary GPS data) may take a few minutes. The unit must remain switched on for the entire duration of this procedure. The vehicle must not be moved. If, after approximately 10 minutes, the unit has not switched to the next display, the parked position (clear view in all directions as far as possible) or the installation location of the GPS antenna must be checked. You can also call up the GPS information and check whether the values displayed there have changed (see the description in GPS information - GPS function test on page 23).

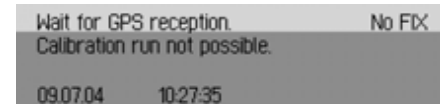
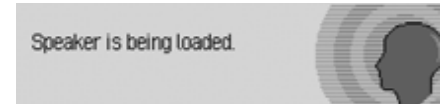
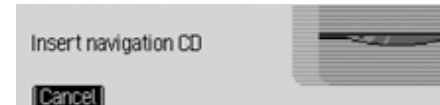
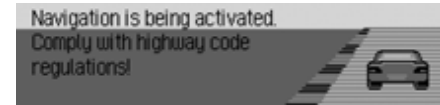

Installation Guide

Once sufficient GPS reception can be assured, the Traffic Pro switches to the next display.

- You are prompted to take a calibration journey.

Carry out the calibration journey.

During the journey, the speed signal (GAL) is automatically adapted to the vehicle-specific data and the gyro sensor is automatically adapted to the installation position of the unit.

The distance to be covered depends on the type of vehicle and the local conditions.

The basic requirement for a calibration journey is: **driving 200 - 300 metres in a straight line, then turning by at least 60 degrees and then driving 200- 300 metres in a straight line again, and turning again.**

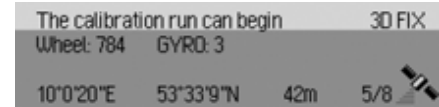

The direction you turn is of no significance. If these conditions cannot be fulfilled due to the road or the fact that you do not always have optimum GPS reception, this will not lead to a poorer calibration, but will simply mean the time and distance necessary for the calibration ride will be longer.

- The Navigation menu appears to indicate that calibration has been completed successfully.



The navigation system is only ready for operation on completion of the calibration journey. Final precision is only achieved after a further journey.

- For correct navigation on routes with time-dependent traffic guidance, the time should be set correctly as described in the operation guide under “Settings” in Navigation mode.

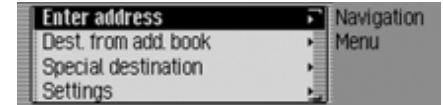

Installation Guide

Service mode

In Service mode, various functions can be checked in detail and the calibration can be modified.

- Switch on the unit (see operation guide).
Enter code (see operation guide).
- Press **□□** and **NAVI** at the same time.
The Service menu appears.

Turn the rotary control/push button **OK** to select one of the following options:

- Status of calibration run - Calibration journey display
- Delete calibration - Function for deleting the calibration
- Sensors - Sensor function test
- GPS Info - GPS function test
- Version - Display of software module versions
- Demo mode - Switch demo mode on/off

Confirm your selection by pressing the rotary control/push button **OK**.

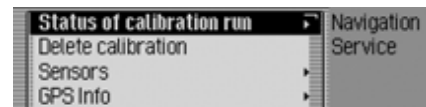

Calibration journey status - Calibration journey display

Select Status of calibration run in the Service menu.

The calibration status (e.g. Status: 2), type of positioning (e.g. 3D FIX), the road along which the vehicle is currently travelling (if available), the current geographical position, the height above sea level (if available) and the number of satellites received are displayed.

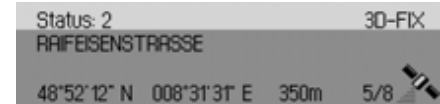

Delete calibration - Function for deleting the calibration

If the Traffic Pro is removed from one vehicle and installed in another, it must be calibrated. However, to do so, the current calibration data must be deleted.

Select Delete calibration in the Service menu.

Select Yes (delete calibration) or No (maintain calibration).

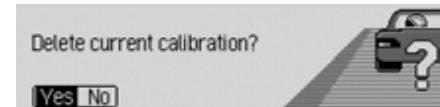

Installation Guide

Sensors - Sensor function test

Select Sensors in the Service menu.

- Move the vehicle several metres forwards or backwards for the speed signal function test.



The number value behind Wheel: must increase (also at low speed).

The number value behind Wheel: should not increase when the vehicle is in neutral or when the accelerator is pressed while the vehicle is parked.

- Engage the reverse gear for the reverse signal function test.



The number value behind Backwards must jump from 0 to 1 (1 to 0).

- Drive round a bend to test the function of the internal sensors.



The value behind GYRO: must change.

Sensors			
Wheel: 784	GYRO: 3	Backwards: 0	
53°33'9"N	10°0'20"E	42m	5/8

GPS information - GPS function test

Select GPS Info in the Service menu.

When functionality and GPS reception are working correctly, the number of satellites received (e.g. 5/8), the date and time and the type of positioning currently possible (e.g. 3D FIX) are displayed.



For successful and fast calibration, a minimum of 2D FIX is required. A certain amount of time may be required to reach this value (do not move the vehicle during this period).

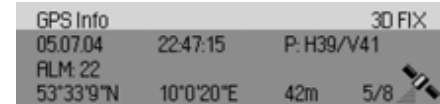

Version - The software module versions are displayed

When the vehicle is being serviced, information about the unit can be accessed here.

Select Version in the Service menu.

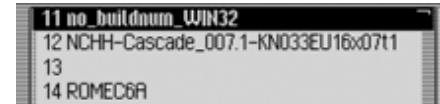

Demo mode - Switch demo mode on/off

Demo mode is intended for demonstration purposes. A fixed location is given to the unit (Ittersbach, Im Stockmädle).

Select Demo mode in the Service menu.

Press the rotary control/push button **OK** to activate () or deactivate () Demo mode.

A destination can now be entered as described in the operation guide even if the unit has not been calibrated.



Installation Guide

Connections

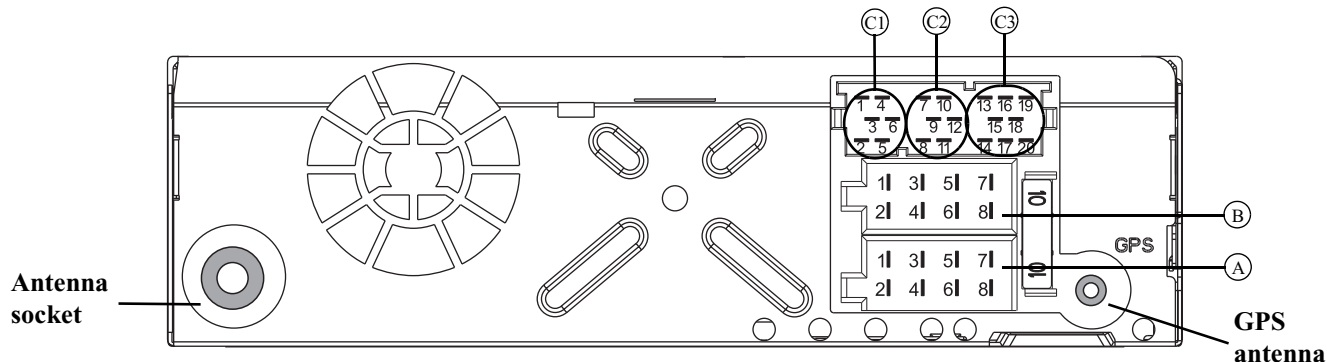

Socket A

- 1 Speed signal (GAL)
- 2 Reversing lamp signal
- 3 Telephone mute/clearing function
- 4 Permanent positive (Terminal 30)
- 5 Control output for automatic antenna/amplifier
- 6 Illumination (Terminal 58)
- 7 Switched positive (Terminal 15)
- 8 Earth (Terminal 31)

Socket B

- 1 Loudspeaker right rear +
- 2 Loudspeaker right rear -
- 3 Loudspeaker right front +
- 4 Loudspeaker right front -
- 5 Loudspeaker left front +
- 6 Loudspeaker left front -
- 7 Loudspeaker left rear +
- 8 Loudspeaker left rear -

Socket C1

- 1 LineOut left rear
- 2 LineOut right rear
- 3 AF Earth
- 4 LineOut left front
- 5 LineOut right front
- 6 Subwoofer LineOut

Socket C2

- 7-12 Specific connection for Becker CD changer

Socket C3

- 13 NF - Hands-free microphone
- 14 Earth - Hands-free microphone
- 15-17 Specific connection for Becker CD changer
- 18 CD AF earth (AUX)
- 19 CD AF left (AUX)
- 20 CD AF right (AUX)