

Safety instructions	53	Programme filtering for FM-DAS	61	CD mode	70
Information regarding general road safety	54	Programme type selection (PTY)	62	Notes on compact discs (CD)	70
Arrangement of controls	55	<i>Turning PTY display on / off</i>	62	Inserting / ejecting CDs	70
Anti-theft device	56	Calling up / storing FM stations	62	Forward / backward track skipping	71
Entering the code number	56	Manual FM tuning	63	Scan search	71
Removing the portable panel	57	Regionalisation	63	Fast forward / reverse	71
Attaching the portable panel	57	<i>Switching regionalisation on / off</i>	64	Track repeat	71
General Operation	58	Turning frequency display on / off	64	Random play	72
Switching on/off	58	Switching radio text on / off	64	CD settings menu	72
Setting the volume	58	Traffic programme (TP)	65	<i>Displaying number of tracks</i>	72
Activating the tone menu	58	<i>Activating / quitting the TP menu</i>	65	<i>Switching between Track/CD</i>	72
<i>Setting the bass</i>	58	<i>Switching TP on / off</i>	65	<i>Text display</i>	72
<i>Setting the treble</i>	58	<i>Selecting automatic tracking</i>	66	Temperature protection circuit	73
<i>Fader</i>	59	<i>Selecting / cancelling direct programming</i>	66	Notes on CD-R and CD-RWs	73
<i>Setting the balance</i>	59	<i>Switching mute on/off</i>	67	Notes on copy-protected CDs	73
<i>Linear adjustment</i>	59	<i>Interrupting TP announcements</i>	67	MP3 mode	74
<i>Adjusting the volume of the subwoofer or centre speaker</i>	59	<i>TP announcement volume</i>	67	General notes on MP3	74
<i>Switching loudness on / off</i>	59	Telephone muting	67	Creating an MP3/WMA storage medium	74
Radio mode	60	Switching on AM mode	68	<i>Creating a playlist</i>	75
Switching on FM mode	60	Switching on AM menu mode	68	Inserting /ejecting MP3 CDs	76
Switching on FM menu mode	60	Selecting the AM waveband	68	Switching between folder/playlist	77
Selecting the FM waveband	60	Setting options for station selection	68	Forward / backward track skipping	77
Settings for station selection	60	<i>Station search MW, LW, SW</i>	68	Changing folder/playlist	77
<i>Dynamic autostore (FM-DAS)</i>	60	<i>Scan search</i>	68	Scan search	77
<i>Station search FM-DAS</i>	61	Calling up/storing MW, LW, SW stations	69	Fast forward / reverse	78
<i>Scan search</i>	61	Autostore MW, LW	69	Random Play	78
		Manual MW, LW, SW tuning	69	Track repeat	78

Contents

MP3 settings menu	78	Service menu	87
<i>Number of folders/playlists/tracks</i>	78	Calling up / exiting service menu	87
<i>Displaying name of folder/playlist</i>	79	<i>CD Changer reset</i>	87
<i>Switching between track/ID3 tag display</i>	79	Unit reset	87
CD changer mode	80	Explanation	91
Operational readiness of CD changer	80	RDS SYSTEM	91
Loading / ejecting the CD magazine	80	DAS Seek Qual. level	91
Selecting CD changer mode	80	DAS Seek Name level	91
Changing/selecting CDs	80	RDS Stations level	91
CDC settings menu	81	Stations Fix level	91
<i>Displaying track information</i>	81	PTY (programme type)	91
<i>Displaying number of tracks and total playing time</i>	81	Technical terminology glossary	93
<i>Naming a CD</i>	82	Index	95
CD filter function	83	Technical data	98
User settings	84	NOTICE	99
Opening / quitting User Settings menu	84		
<i>Setting the GAL (Gal)</i>	84		
<i>Telephone mute function (Tel)</i>	84		
<i>Display brightness (Lum)</i>	85		
<i>LED setting</i>	85		
<i>Setting reception optimisation (M/S)</i>	85		
<i>AUX input (Aux)</i>	86		
<i>Signal tone volume (BeV)</i>	86		



Safety instructions

Operation of the unit is permitted only if traffic conditions are suitable and you are absolutely sure that you, your passengers or other motorists are not endangered, obstructed or inconvenienced.

The unit may only be used for its intended purpose. The volume of the radio should be adjusted so that external noise is still audible.

In the case of a malfunction (i.e. smoke or other noticeable odours) the unit is to be turned off immediately.

For safety reasons, the unit may only be opened by a trained technician. Please refer to your dealer for repair.

Information regarding general road safety

This car radio device is intended and approved for installation and operation in passenger cars, commercial vehicles and buses (vehicle classes M, N and O) whose electric system has a rated voltage of 12V.

Installation and maintenance should only be carried out by specialists. Faulty installation or maintenance can result in the malfunctioning of the motor vehicle's electronic systems. The vehicle manufacturer's safety instructions must be observed.

The vehicle's electronics (e.g. speedometer signal) may only be worked on by an authorised service garage. We assume no liability for any impairment of the vehicle's electronics.

This device is only intended for installation in the area provided for this purpose by the vehicle manufacturer.

The method of attachment used must ensure that the device will remain properly attached, should the vehicle be involved in a crash.

The power supply must be properly fused.

Using mobile phones without an external antenna in the proximity of the radio unit may cause interference.

Familiarise yourself with the device and how it works before embarking on your journey. Whilst on the move, only operate the device in appropriate traffic conditions. The volume of the device should be set at a level that enables external noises (e.g. police sirens) to be easily heard.

Arrangement of controls

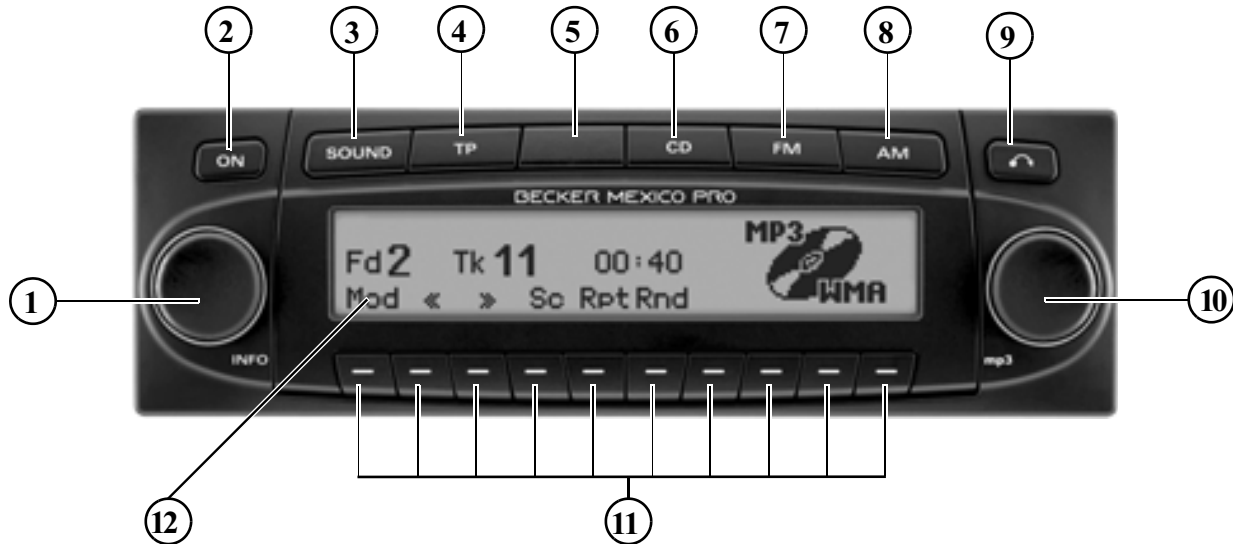

- 1 Left rotary control ● (INFO)
- 2 On / off switch (ON)
- 3 Tone button (SOUND)
- 4 Road traffic announcement button (TP)
- 5 LED
- 6 Select CD mode (CD)

- 7 FM selection (FM)
- 8 AM selection (AM)
- 9 CD eject button (eject symbol)
- 10 Right rotary control ●
- 11 Multifunction buttons
- 12 Display

Anti-theft device

Entering the code number

If the car radio is disconnected from the electrical supply source, the anti-theft device prevents it from being reconnected. After turning on the unit via the **ON** button, the prompt **Enter Code Number** is displayed.

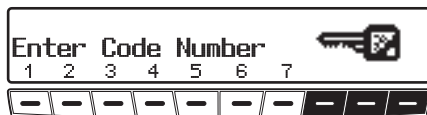

- Use the multifunction keys **1** - **7** to enter the five-digit code number.

Example:

Code number 15372 (the code number can be found on the enclosed CODE CARD).

The unit automatically switches on when the fifth digit is entered and all other digits were entered correctly.

Note

It is important to store the CODE CARD in a safe place outside of the vehicle. This will prevent unauthorised use. The window stickers provided should be attached to the windscreen/windows inside your vehicle.

In an incorrect code number is entered, the prompt **Enter Code Number** will be displayed once again. If an incorrect code number is entered three times in a row, the unit will display **Wait**, and it will be blocked for approximately 60 minutes.

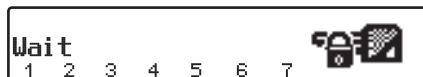

Three further incorrect entries block the unit for another 60 minutes.

Attention:

The waiting time elapses only when the ignition and unit are switched on.

Removing the portable panel

As an effective anti-theft device, the portable panel (A) may be removed from the unit.

- ▶ Press button  briefly (storage medium remains in the unit). The display folds forwards.
- ▶ Detach the portable panel.

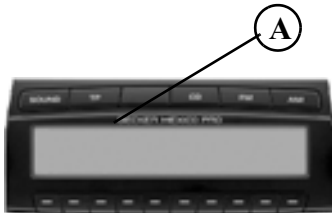

The volume is limited to a maximum level after the display has been folded down. After 20 seconds, an audible signal indicates that the control component is folded down. The unit then switches itself off.



Warning **Accident hazard**

For safety reasons, the portable panel may not be left open while driving.

Attention:

Please insert the portable panel in the accompanying protective cover after removal.

Do not touch the metal contacts on the portable panel or on the radio.

Attaching the portable panel

- ▶ Insert the portable panel into the lower left catch and then engage it in the lower right catch. Then fold up the portable panel and engage it in the upper catches.

The portable panel can also be placed flat against the unit and pushed into place.

To ensure correct function, be sure that the portable panel is completely seated in all four catches.

General operation

Switching on/off

- ▶ Press **ON**.

The unit can also be switched on/off via the vehicle ignition.

To switch the unit on via the ignition, the unit must have previously been turned off via the ignition.

After switching off the ignition, the unit can be prevented from switching off by pressing the **ON** button within 3 seconds.

Note:

The unit can also be switched on with the ignition switched off via the **ON** button, but it will switch off automatically after 1 hour.

Setting the volume

Turn the left-hand rotary control ●. The volume increases or decreases.

Activating the tone menu

Press **SOUND**. The tone menu is activated. The following functions can be called up: **Bas** (Bass), **Trb** (Treble), **Fad** (Fader), **Bal** (Balance), **FLt** (Linear adjustment), **Sub** (Subwoofer) and **Ldn** (Loudness).

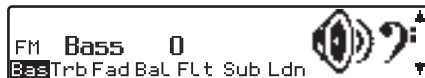

Settings for bass and treble, for the FM, AM (MW, LW, SW) wavebands, for road traffic announcements, telephone mode, CD, MP3/WMA and CDC/AUX mode are stored separately.

Setting the bass

- ▶ Press the **SOUND** button and then the **Bas** multifunction button.



- ▶ Set the desired bass level using the right-hand rotary control ●.

Setting the treble

- ▶ Press the **SOUND** button and then the **Trb** multifunction button.



- ▶ Set the desired treble level using the right-hand rotary control ●.

Fader

- ▶ Press the **SOUND** button and then the **Fad** multifunction button.



- ▶ Use the right-hand rotary control to achieve the desired fader setting.

Setting the balance

- ▶ Press the **SOUND** button and then the **Bal** multifunction button.



- ▶ Set the desired balance level using the right-hand rotary control.

Linear adjustment

The tone adjustments for the current signal source (i.e. FM) can be reset to a mid-level.

- ▶ Briefly press the **SOUND** button. Then press multifunction button **FLt** briefly - Tone reset will appear.



- ▶ Press the **FLt** multifunction button again.

Adjusting the volume of the subwoofer or centre speaker

- ▶ Press the **SOUND** button and then the **Sub** multifunction button.



- ▶ Use the right-hand rotary control to achieve the desired subwoofer volume setting.

Switching loudness on / off

- ▶ Press the **SOUND** button and then the **Ldn** multifunction button.



- ▶ With multifunction button **Ldn** you can select either Loudness on (ON) or Loudness off (OFF).

Note:

Loudness is switched off in MW, LW and SW wavebands.

Radio mode

Switching on FM mode

- ▶ Press **FM**.

The FM waveband will start up with the memory level and frequency that was last selected.

Switching on FM menu mode

- ▶ Press **FM** in radio mode.



The radio menu mode is activated and displayed. The unit switches back to radio mode if no button is pressed within the next 8 seconds.

Selecting the FM waveband

- ▶ Request radio menu mode.



- ▶ Press the **Fm** multifunction button.

The last selected station and level are displayed.

By pressing repeatedly, you can choose between the levels **Seek Quality**, **Seek Name**, **Stations RDS** and **Stations Fix**.

- **Seek Quality** (see also page 91)
- **Seek Name** (see also page 91)
- **Stations RDS** (see also page 91)
- **Stations Fix** (see also page 91)

Settings for station selection

The desired station can be selected via dynamic autostore, station search, scan search, manual tuning, and station buttons.

Dynamic autostore (FM-DAS)

- ▶ Request FM menu mode.



- ▶ Press the **Fm** multifunction button repeatedly until **Seek Quality** or **Seek Name** is displayed.

In the FM-DAS mode, the receivable stations are displayed via the multifunction buttons depending on the settings.



Set the desired station by pressing the button directly below the abbreviated station designation. If the selected station broadcasts several programmes/regional programmes, a submenu is automatically displayed to select the desired programme.



If a programme has previously been selected that belongs to the particular station programming chain, the last stored programme entry will be automatically selected.

Multifunction button  indicates that, by pushing this button, other stations can be displayed and selected.

If station names are being misused to send advertisements or messages, this station is indicated with L-1... L-Z (L = Local) instead of the abbreviated station name. This prevents the lower display line from constantly changing. When a station is selected, it is identified by a star (i.e. L*1).

The first time the unit is operated, or after the electrical supply has been interrupted, it may take the radio some time to evaluate the station signals. The display will appear incrementally as the evaluation progresses.

Station search FM-DAS

- ▶ Turn the right-hand rotary control ● to the left or right.

The radio displays the receivable and identified stations in descending/ascending order.

Scan search

- ▶ Press the right-hand rotary control ●.



 appears on the display.

An automatic station search will be initiated. The first run is performed on an insensitive plane, all further runs on a sensitive plane. Receivable stations will remain audible for 8 seconds. If you wish to store one, press the right-hand rotary control ●.

Note

With **Seek Quality** and **Seek Name**, Scan Search is conducted in alphabetical order.

Programme filtering for FM-DAS

You have the option of filtering various stations from the FM-DAS station list.

- ▶ Request FM menu mode.



- ▶ Press the **Fil** multifunction button.
- ▶ The individual programmes can be selected using the right-hand rotary control ●. By pressing the right-hand rotary control ●, you can choose between **PLAY** (programme unfiltered) and **SkIP** (programme filtered out).

Press the **Fil** multifunction button repeatedly to turn the filter function on (**Fil on**) or off (**No Fil**).

Radio mode

Programme type selection (PTY)

- ▶ Request FM menu mode.



- ▶ Press the **Pty** multifunction button.
- ▶ Then select the desired PTY (see also page 91) using multifunction button **Pty**.

Note

Only the currently available PTYs can be selected.

Once a PTY has been selected, only those stations can be selected in FM-DAS mode that are provided with this PTY.

By selecting **NO PTY** whilst in FM-DAS mode, all stations will once again be displayed.

Turning PTY display on / off

- ▶ Select FM menu mode.



- ▶ With the **Dis** multifunction button, select either **PTY** (PTY display on) or **Frequency** (PTY display off).

Calling up / storing FM stations

- ▶ In the FM menu mode, select the **Stations RDS** or **Stations Fix** level using the **Fm** multifunction button.

- **Stations RDS** (see also page 91)
- **Stations Fix** (see also page 91)

Storing:

12 frequencies or programmes can be stored per waveband.

- ▶ Find desired station.

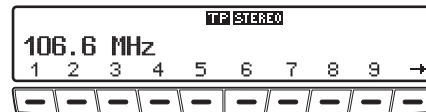

- ▶ To store the desired station or programme, press multifunction button **1** - **9** or **10** - **12** until you hear a signal tone.

Note

To reach presets 10 – 12, press the **→** multifunction button.

Calling up a preset:

- ▶ Press multifunction button **1** - **9** or **10** - **12** and the stored station will be called up.

Manual FM tuning

- ▶ Select FM menu mode.
- ▶ Using the **Fm** multifunction button select the **Stations Fix** level.



- ▶ Press the **Man** multifunction button twice.
- ▶ Next, turn the right-hand rotary control ●.

100 kHz tuning steps are performed. The display will show that manual tuning is currently active with **MAN**. If the right-hand rotary control ● is not turned after a short time, **MAN** will disappear from the display and manual tuning is turned off.

Regionalisation

The RDS diversity function is independent of region. As a result, the RDS diversity function can lead to the radio switching between various regional programmes which may vary in terms of broadcasting content. In such a case, the special regional programming must be selected directly.

If several regional programmes are transmitted by one station, this can only be seen when the station is selected. Stations with additional regional transmitters are indicated with a star (i.e. **4***).



Upon selection of one of these stations (e.g. **4***), all receivable regional sub-programmes for this station will be displayed.



- ▶ Then select the desired regional sub-programme (i.e. **Ma**).

Note

If the signal quality of a regional alternative drifts despite the RDS diversity function, it may mean that regional alternatives are only transmitted on a few frequencies. Therefore, there are fewer frequencies with strong signals available for the unit to switch to.

Radio mode

Switching regionalisation on / off

- ▶ Select FM menu mode.



- ▶ Use the **Res** multifunction button to turn regionalisation on (on) or off (off).

Turning frequency display on / off

- ▶ Select FM menu mode.



- ▶ Use the **Dis** multifunction button to select either **Frequency** (frequency display on) or **PTY** (frequency display off).

Switching radio text on / off

Warning **Accident hazard**

Since information transmitted via radio text is constantly changing, we recommend displaying the radio text only when the vehicle is stationary to avoid unnecessary distraction for the driver. This is a necessary precaution for accident prevention.

- ▶ Press the left-hand rotary control ●.

```
** TEXT ** TEXT ** TEXT ** TEXT  
** TEXT ** TEXT ** TEXT ** TEXT  
FM   PtyDisRes   Fil
```

The car radio filters data transmitted by the radio station and displays it in the form of radio text.

Note

Radio text cannot be displayed unless the selected station transmits radio text. Poor reception or interference may distort the radio text or completely prevent it from being displayed.

- ▶ In order to quit the radio text level, press the **FM** button or the left-hand rotary control ●.

Traffic programme (TP)

If an RDS diversity station broadcasts TP announcements, it is possible to interrupt CD, CDC/AUX, MW, LW, SW mode or the mute mode and switch the broadcast TP announcements through. Moreover, you can listen to one FM station while receiving TP announcements transmitted by another FM station.

There are two ways to select a TP station:

- **Automatic tracking**
- **Direct programming**

Automatic tracking transmits TP bulletins over the FM station currently being received. If the selected FM station has poor signal quality or is not a TP station, the unit applies specified criteria to search for a new TP station.

Direct programming enables a TP station to be programmed that is not the FM station being received. This means, for example, that a particular FM station can be listened to whilst TP announcements are received from another one.

If the programmed TP station's reception is poor, the unit switches to automatic tracking until the programmed TP station can be restored.

If the unit detects a TP station, this is indicated on the display by TP.

TP appears on the display to indicate that the traffic programme is active.

Activating / quitting the TP menu

Activating:

- ▶ Press the **TP** button (traffic announcements cannot be transmitted).



- ▶ Press the **TP** multifunction button.

Quitting:

- ▶ Press the **TP** button; otherwise the TP menu will automatically disappear after 8 seconds if no further operations are performed.

Switching TP on / off

In all modes and wavebands, TP can be turned on or off by pressing and holding the **TP** button for more than 2 seconds.

TP can also be switched on or off whilst in the TP menu:

Radio mode

Switching on:

- ▶ Switch on TP menu.



- ▶ Press **TP** multifunction button repeatedly until TP **on** appears.

Switching off:

- ▶ Switch on TP menu.



- ▶ Press **TP** multifunction button repeatedly until TP **off** appears.
TP is switched off after returning to normal display.

Selecting automatic tracking

In all modes and wavebands, automatic tracking can be turned on by pressing and holding the **TP** button for more than 2 seconds.

In the TP menu:



- ▶ Press **TP** multifunction button repeatedly until TP **on** appears.

Attention:

If a TP station has already been programmed directly, it will once again be selected as the TP station.

Selecting / cancelling direct programming

- ▶ Switch on TP menu.

Selecting:

- ▶ Press the **Sta** multifunction button.



- ▶ Using the right-hand rotary control , select the desired TP station and press to confirm.

After a short delay and without actuation, the selected station is accepted.

Cancelling:

- ▶ Press the **Sta** multifunction button.



- ▶ Select **Autoselect** with the right-hand rotary control  and press the control to confirm.

After a short delay and without actuation, direct programming is cancelled.

Switching mute on/off

- ▶ After selection of a TP or EON station, the mute function can be activated by pressing the **TP** button briefly.



Thereafter, only traffic announcements and navigation announcements will be switched through.

- ▶ The mute function is cancelled by pressing the **TP** button again.

Interrupting TP announcements

An announcement currently being broadcast can be interrupted.

- ▶ Briefly press the **TP** button during the TP announcement.

The unit switches back to the previously selected mode.

TP announcement volume

- ▶ Select TP menu.
- ▶ Press the **Vol** multifunction button.



- ▶ With the right-hand rotary control ●, four different settings (0 - 3) can be selected.

This means that the volume can be raised by a fixed amount depending on the setting.

- Setting 0 - no increase
- Setting 1 - slight increase
- Setting 2 - moderate increase
- Setting 3 - large increase

Telephone muting

If a telephone is installed in the vehicle and its mute control is linked to the car radio, the User menu (page 84) can be used to determine how it should behave. If **Mute** is selected, the radio is muted when a call is received.

With the setting **Audio Sys.** the sound of the telephone will be heard through the radio unit if a call comes in (vehicle ignition must be on).

This is only possible if, in addition to the telephone, a hands-free unit with loudspeaker output is installed and connected to the radio. In both cases **Phone** will be displayed.



Radio mode

Switching on AM mode

- ▶ Press **AM**.

The last selected AM station and the corresponding waveband are selected.

Switching on AM menu mode

- ▶ Press the **AM** button whilst in AM mode.

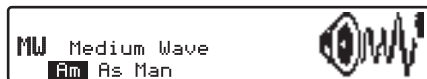

The AM menu mode is activated and displayed. The unit switches back to radio mode if no button is pressed within the next 8 seconds.

Selecting the AM waveband

- ▶ Request AM menu mode.



- ▶ Press the **Am** multifunction button.

The last selected waveband and station are set.

To select the MW (Medium Wave), LW (Long Wave) and SW (Short Wave) wavebands, repeatedly press the **Am** multifunction button until the desired waveband is set.

Setting options for station selection

The desired station can be selected via station search, Autostore (MW, LW), scan search, manual tuning and station buttons.

Station search MW, LW, SW

- ▶ On the desired waveband (MW, LW, SW) turn the right-hand rotary control ● to the left or right.

The radio searches for reception frequencies in descending or ascending order of frequency.

Scan search

- ▶ In the desired waveband (MW, LW, SW) press the right-hand rotary control ●.

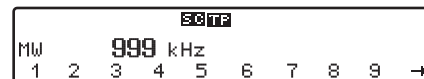

SC appears on the display.

An automatic station search will be initiated. The first run is performed on an insensitive plane, all further runs on a sensitive plane. Receivable stations will remain audible for 8 seconds. If you wish to store the station received, press the right-hand rotary control ●.

Calling up/storing MW, LW, SW stations

Storing:

In each case up to 12 stations can be stored using the station buttons.

- ▶ Find desired station.

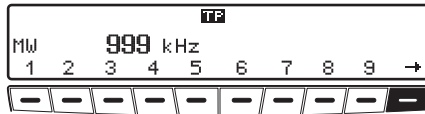

- ▶ To store the desired station, press the multifunction button **1** - **9** or **10** - **12** until you hear a signal tone.

Note

To reach presets 10 – 12, press the **→** multifunction button.

Calling up stations:

- ▶ Press multifunction button **1** - **9** or **10** - **12** and the stored station will be called up.

Autostore MW, LW

- ▶ Select AM menu mode within the desired waveband.



- ▶ Press the **As** multifunction button repeatedly until **Autostore on** is displayed.
- ▶ Press the **As** multifunction button until **Seek Autostore** is displayed.

The 12 stations with the best reception are stored under the station buttons in order of quality.

- ▶ To exit the Autostore memory level, turn off the Autostore memory (**Autostore off**) with the **As** multifunction button.

The radio switches back to the station button level.

Manual MW, LW, SW tuning

- ▶ Select AM menu mode within the desired waveband.



- ▶ Press the **Man** multifunction button twice.
- ▶ Next, turn the right-hand rotary control ●.

9kHz (MW), 3kHz (LW) or 5kHz (SW) tuning steps are performed.

The display will show that manual tuning is currently active with **MAN**. If the right-hand rotary control ● is not turned after a short time, **MAN** will disappear from the display and manual tuning is turned off.

CD mode

Notes on compact discs (CD)

Sound interruptions may occur if the CD is soiled. In order to ensure the highest tone quality, please note the following:

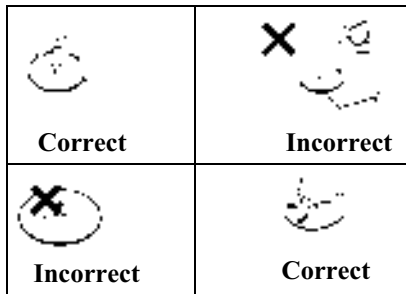



- Always touch the CD at the edges only. Keep the disc clean and never touch the surface.
- Never stick anything on the CD.
- Protect the CDs against direct sunlight and from heat sources such as heaters etc.

- Before playing the CD, it should be cleaned with a special, commercially available cleaning cloth, wiping from the centre outwards. Solvents such as benzene, thinners or other commercially available cleaners and anti-static sprays must not be used.

Inserting / ejecting CDs

Inserting CDs:

- ▶ Press and hold .
- The display folds downwards and the CD slot is then visible.
- ▶ Insert the disc into the CD slot with the printed side upwards.
- The unit pulls in the CD automatically and begins to play the disc from the first track. Then fold the display up again. After the last track has finished playing, the unit will automatically repeat the CD from the first track.

If there is already a CD in the slot, press the  button. If CD-changer/AUX mode was selected last, the unit must be switched to CD mode by pressing the  multifunction button.

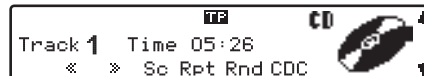

Ejecting CDs:

- ▶ Press and hold .
- The display folds downwards and the CD is ejected.
- ▶ Removing CDs.
 - ▶ Fold the display up again.



Warning **Accident hazard**

For safety reasons, the portable panel may not be left open while driving.

Attention:

The CD is not ejected when the unit is switched off but remains in the CD slot.

Forward / backward track skipping

- ▶ Turn right rotary control ● to right / left.

Through further turning of the right rotary control ●, several tracks can be skipped over in forward or reverse directions.

Note:

The unit switches to the first track once the last track is reached. In a similar manner, it switches from the first track back to the final track.

If a track has been playing for more than 10 seconds when the skip button is pressed, the unit will skip back to the beginning of the selected track.

Scan search

- ▶ Pressing the **Sc** multifunction button activates the scan search function.



Sc appears on the display.

All following tracks on the current CD are played for 10 seconds each. Press the **Sc** multifunction button again to terminate the scan search.

Fast forward / reverse

- ▶ Fast forward (audible) is activated by pressing the **FF** multifunction button and fast reverse (audible) is activated by pressing the **RR** multifunction button.



- ▶ Fast forward / reverse terminates when the multifunction button **FF** or **RR** is released.

Track repeat

- ▶ “Track repeat” is activated by pressing the **Rpt** multifunction button.

The prompt **Rpt** is displayed inversely.



- ▶ Pressing the **Rpt** multifunction button again deactivates “Track repeat”.

CD mode

Random play

- ▶ Pressing the **Rnd** multifunction button activates the random play function.

Subsequently, the tracks on the current CD will be played in random order. The prompt **Rnd** is displayed inversely.



- ▶ Pressing the **Rnd** multifunction button again deactivates the “Random Play” function.

CD settings menu

- ▶ Press the **CD** button in CD mode.



The CD settings menu is displayed. As additional information, if available, CD text on the track currently playing is displayed.

If another function is selected in the CD settings menu, you can display the CD text again by pressing the **Trk** multifunction button.

Displaying number of tracks

- ▶ Requesting CD settings menu.



- ▶ Press the **Trk** multifunction button. The current track number and the total number of tracks are displayed.

Switching between Track/CD

Text display

You can set here whether in the CD menu the track display is provided by the numerical track display or by displaying the CD text for the current track.

- ▶ Press the left-hand rotary control ●.
- or
- ▶ Requesting CD settings menu.



- ▶ By pressing the **Dis** multifunction button, select either **Numeric** (track display), or **Text** (track name).

Temperature protection circuit

To protect the laser diode from excessive heat, a temperature protection circuit is integrated into the unit.

When the temperature threshold of this protection circuit is activated, the following display is given for 8 seconds.



The unit switches to the operating mode selected before CD mode was activated. After a cool down period, the CD mode may be called up again. If the temperature is still too high, the unit will once again switch back to the previously selected signal source.

Notes on CD-R and CD-RWs

You can play CD-Rs (writeable CDs) and CD-RW (rewritable CDs) on this unit, but please comply with legal restrictions. These restrictions may vary from one country to another.

Depending on the recording device used to record the CD-R/CD-RW and / or the CD-R/CD-RW itself, it may not be possible to play some CD-Rs/CD-RWs on this unit.

CD-Rs/CD-RWs must be manufactured according to the “Red Book” standard (not applicable for MP3 CDs).

Notes on copy-protected CDs

In some cases, problems may arise when attempting to play copy-protected CDs, such as long reading times or a total inability to perform playback.

MP3 mode

General notes on MP3

The music that can be played when your unit is in MP3 mode is generally copyright-protected under applicable international and national laws. In several countries, the reproduction of copyrighted material is not permitted, even if only for personal use, without the express prior consent of the copyright holder. Please check the current copyright laws for your country and comply with them. These restrictions naturally do not apply to your own compositions and recordings, or for recordings for which authorisation has been obtained from the copyright holder.

Creating an MP3/WMA storage medium

- The maximum number of tracks per medium depends on the number of folders and file name length. Here, for a full file name length, it can be assumed that for 0 folders about 240 tracks and for, e.g., 50 folders a total of around 160 tracks are possible.
- Only MP3 and WMA tracks stored on a CD in compliance with ISO 9660 can be played.
- If the artist's name and track title are to be displayed, an ID3 tag must be added to the MP3 file. This unit supports versions ID3v1 and ID3v2.
- The display of artist's name and track title is restricted to a total maximum length of 24 characters.
- The MP3 formats MPEG1, MPEG2 and MPEG2.5 Layer3 are supported by the unit.
Fixed and variable bit rates of 8 - 320 kbit/s and scan rates of 8 - 48 kHz are supported. For creating MP3 files, we recommend using the MP3 encoder from Fraunhofer.

For WMA, WMA 9 with a bit rate of 64 - 320 kbit/s is supported. For creating WMA, we recommend using Windows Media Player Version 9 from Microsoft®.

- We recommend a bit rate of at least 160 kbit/s for compressing MP3 files. It should be noted that with MP3 files having a variable bit rate, the display of the elapsed playing time may deviate from real time.
- If both MP3/WMA data and conventional audio tracks are included on the CD it is usually referred to as a mixed-mode CD. On this kind of CD the audio tracks are generally located in the first directory on the CD.

- You can play CD-Rs (writeable CDs) and CD-RWs (rewritable CDs) on this unit,
You can also use multisession CDs, but a multisession CD must be finalized before it can be played.
Depending on the recording device used to record the CD-R/CD-RW and / or the CD-R/CD-RW itself, it may not be possible to play some CD-Rs/CD-RWs on this unit.

For further information about creating MP3/WMA files and ID3 tags, please consult your dealer or check on the Internet.

Note:

Due to the abundance of different kinds of CD burning software and their associated settings we cannot guarantee the playback quality of MP3/WMA CDs.

Creating a playlist

Due to the number of MP3 files that can be saved on an MP3 CD, the MP3 CD quickly becomes confusing. You can make it less confusing using playlists.

In a playlist, you can combine, for example, all the desired songs in a category (e.g. rock).

This playlist can then be burned on the CD together with the MP3 files that are stored in folders.

The unit recognises this playlist (several possible) on reading the MP3 CD and can then play the MP3 tracks in the order specified by the playlist.

In this case, the playlist mode must be activated as described in “Switching between folder/playlist” on page 77.

We used the freeware WINAMP in our trials for creating playlists. Other programs may also be used to create playlists.

The playlist formats M3U and PLS are supported by the unit.

Note:

Please note that M3U and PLS playlists are only supported by the unit if these have been created using relative specified paths.

For further information about creating playlists, please check on the Internet.

MP3 mode

Inserting /ejecting MP3 CDs

Inserting CDs:



- ▶ Press and hold .

The display folds downwards and the CD slot is then visible.

- ▶ Insert the MP3 CD into the CD slot with the printed side upwards.

The unit pulls in the MP3 CD automatically and begins to play the first track in the first folder (directory) of the CD. Then fold the display up again.

After the last track in the last folder on the MP3 CD has finished playing, the unit will automatically repeat the first track in the first folder on the CD.

If there is already an MP3 CD in the slot, press the  button. If CD-changer/AUX mode was selected last, the unit must be switched to MP3 mode by pressing the  multifunction button.



Ejecting CDs:

- ▶ Press and hold .

The display folds downwards and the MP3 CD is ejected.

- ▶ Removing MP3 CDs.
- ▶ Fold the display up again.



Warning

Accident hazard

For safety reasons, the portable panel may not be left open while driving.

Attention:

The MP3 CD is not ejected when the unit is switched off but remains in the CD slot.

Also refer to the following sections under CD mode (Page 70):

- “Notes on compact discs (CD)” on page 70
- “Temperature protection circuit” on page 73

Switching between folder/ playlist

If playlists are stored on the inserted MP3 CD, it is possible to switch between the folder display and the playlist display.



- ▶ By pressing the multifunction button **Mod** select either **FoLder Mode** or **PLayList Mode**.
- **FoLder Mode**
In the folder display, all the MP3 tracks on the MP3 CD can be played. Active folder display can be recognised from the abbreviation **Fd**.
- **PLayList Mode**
In the playlist display, only the MP3 tracks saved in the various playlists can be played. Active playlist display can be recognised from the abbreviation **PL**.

Note:

The **Mod** multifunction button is only displayed when playlists are saved on the inserted MP3 CD.

Forward / backward track skipping

- ▶ Turn right rotary control ● to right / left.

Through further turning of the right rotary control ●, several tracks can be skipped over in forward or reverse directions.

Note:

The unit switches to the first track in the folder or playlist once the last track in the folder or playlist has been reached. In a similar manner, it switches from the first track back to the final track. If a track has been playing for more than 10 seconds when the skip button is pressed, the unit will skip back to the beginning of the selected track.

Changing folder/playlist

- ▶ Press the right rotary control ●.
- ▶ Turn the right rotary control ● to select the desired folder or the desired playlist.
While making the selection, the folder names or playlist names are displayed.

Scan search

- ▶ Pressing the **Sc** multifunction button activates the scan search function.



Sc appears on the display.

All following tracks in the current folder or current playlist are played for 10 seconds each. Press the **Sc** multifunction button again to terminate the scan search.

MP3 mode

Fast forward / reverse

- ▶ Fast forward (audible) is activated by pressing the **⏩** multifunction button and fast reverse (audible) is activated by pressing the **⏪** multifunction button.



- ▶ Fast forward / reverse terminates when the multifunction button **⏩** or **⏪** is released.

Random Play

- ▶ Pressing the **Rnd** multifunction button activates the random play function.

Subsequently, the tracks from the current folder or current playlist will be played in random order. The prompt **Rnd** is displayed inversely.



- ▶ Pressing the **Rnd** multifunction button again deactivates the “Random Play” function.

Track repeat

- ▶ “Track repeat” is activated by pressing the **Rpt** multifunction button.

The prompt **Rpt** is displayed inversely.



- ▶ Pressing the **Rpt** multifunction button again deactivates “Track repeat”.

MP3 settings menu

- ▶ Press the **CD** button whilst in MP3 mode.



The MP3 settings menu is displayed. As additional information, if available, the ID3 tag for the track currently playing is displayed.

If another function is selected in the MP3 settings menu, you can display the ID3 tag again by pressing the multifunction button **Txt**.

Number of folders/playlists/tracks

- ▶ Requesting MP3 settings menu.



- ▶ Press the **Trk** multifunction button. The current folder or playlist number and the current track number are displayed.

or



- ▶ Press the **Ttl** multifunction button. The total number of playlists (**PL**), folders (**Fd**) on the MP3 CD and the total number of tracks (**Tk**) are displayed.

Displaying name of folder/ playlist

- ▶ Requesting MP3 settings menu.



- ▶ Press multifunction button **Fd** or, if you are in the playlist display, multifunction button **PL**.

The name of the folder or the playlist is displayed.

Switching between track/ID3 tag display

Here you can set whether in the MP3 menu the track display is provided by the numerical track display or by displaying the ID3 tag for the current track.

- ▶ Press the left-hand rotary control ●.
- or
- ▶ Requesting CD settings menu.



- ▶ By pressing the **Dis** multifunction button, select either **Numeric** (track display), or **Text** (track name).

CD changer mode

Operational readiness of CD changer

If a CD changer is connected to the car radio, the CD changer is ready for operation as soon as the filled CD magazine is loaded. Close the sliding cover after loading. All further operation is performed from the car radio control panel.

Loading / ejecting the CD magazine

To remove the CD magazine, open the sliding cover on the changer and press the eject button. The magazine is ejected and can be removed.

When inserting CDs into the magazine, please note the instructions printed on the magazine.

Attention:

Incorrectly inserted CDs will not be played.

Note:

To allow for the fastest possible change of CDs, the magazine should be loaded successively, beginning with compartment 1.

Selecting CD changer mode

▶ Press **CD**.

If the CD Changer mode was selected last, or if there is no CD or Navigation CD inserted into the CD player, the unit will now be in the CD Changer menu.

If CD mode was selected last, the unit must be switched to CD changer mode by pressing the **CDC** multifunction button.

Playback begins with the last CD played, at the track playing before switching off.

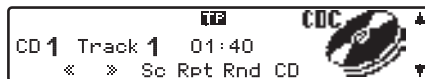

Changing/selecting CDs

▶ Activating CD changer mode.

▶ Press the right rotary control .

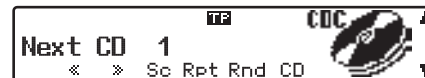

▶ Turn the right rotary control  to select the desired CD.

The selected CD is loaded.

During the selection time, **Loading CD X** is displayed.

The magazine compartment number or the name of the CD and the number of the current track on the selected CD are then displayed.

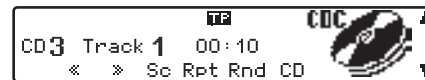

If no CD is loaded in the selected magazine compartment (e.g. compartment 2), **NO CD X** will briefly appear on the display and the previously played CD is played again.

After playing the last track of a CD, the unit automatically selects and plays the next CD in the magazine.

For additional operating instructions, refer to CD mode (Page 70):

- “Notes on compact discs (CD)” on page 70
- “Forward / backward track skipping” on page 71
- “Scan search” on page 71
- “Fast forward / reverse” on page 71
- “Random play” on page 72
- “Track repeat” on page 71

CDC settings menu

- ▶ Press the **CD** button in CDC mode.

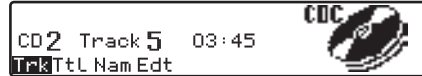

The CDC settings menu is displayed. At the same time, the current CD number, the track number and the current track playing time are displayed.

Displaying track information

- ▶ Requesting CDC settings menu.



- ▶ Press the **Trk** multifunction button. The current CD number, the track number and the current track playing time are displayed.

Displaying number of tracks and total playing time

- ▶ Requesting CDC settings menu.

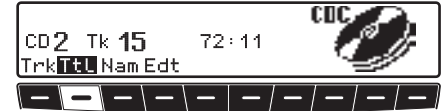

- ▶ Press the **Ttl** multifunction button. The current CD number, the number of tracks and the total playing time are displayed.

CD changer mode

Naming a CD

It is possible to assign a name to the CD currently playing, change a previously assigned name and delete stored names.

Note:

The entered name is stored in the CD changer.

Only a limited amount of memory is available for CD names.

If you replace your CD-changer, the stored names are lost.

Displaying names:

- ▶ Requesting CDC settings menu.



- ▶ Press the **Nam** multifunction button. The assigned name is displayed. If no name was previously assigned to the current CD, the space after **Name:** is blank.



Assigning/changing names:

- ▶ Requesting CDC settings menu.





- ▶ Press the **Edt** multifunction button.

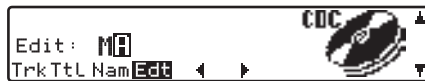

- ▶ Using multifunction buttons  and , select the desired position (inverse editing symbol).



- ▶ By turning the right rotary control , select the required letters and press the right rotary control  to confirm. This advances it by one character. A maximum of 8 characters can be entered. After exiting the CDC settings menu, the name is saved.

Deleting saved names:

- ▶ Requesting CDC settings menu.
- ▶ Press the **Nam** multifunction button.
- ▶ Using the right rotary control , select the name to be deleted.



- ▶ Now, press the **Del** multifunction button to delete the name.

CD filter function

You can filter out individual tracks on a CD. These tracks are then not included when the CD is played.

Note:

The filter function can only be activated if a name has been stored for the selected CD.

- ▶ Requesting CDC settings menu.



- ▶ Then press the **Fil** multifunction button.

Switching filter function on/off

- ▶ By repeatedly pressing the **Fil** multifunction button, the filter function is switched on (**Fil on**) and off (**No Fil**).

Filtering tracks:

Silverstone 7860 and 2660 CD changers.

- ▶ The tracks to be filtered out of the current CD can be selected using the right rotary control ●.
- ▶ By pressing the right rotary control ● you can select **PL ay** (track unfiltered) and **Sk i p** (track filtered out).

Note:

For the Silverstone 2630 and 2640 CD changers, you can choose between **PL ay** (track unfiltered) and **Sk i p** (track filtered out) for the current track by pressing the right rotary control ●.

User settings

Opening / quitting User Settings menu

After requesting the user settings, the following basic settings can be selected according to your personal preferences.

- **Gal** - Speed-dependent volume control (GAL)
- **Tel** - Telephone response
- **Lum** - Display brightness
- **Led** - Adjusting LED
- **M/S** - Adjusting reception optimisation
- **Aux** - Adjusting the AUX input
- **BeU** - Adjusting signal tone volume

- ▶ The user menu is requested by pressing the **SOUND** button for longer than 2 seconds.



- ▶ Press the **SOUND** button again to quit the user menu.

Setting the GAL (Gal)

The GAL is a car radio control circuit, which automatically adjusts the car radio volume according to vehicle speed. This results in compensation of the driving noise produced at higher speeds.

- ▶ Calling up the user menu.
- ▶ Press the **Gal** multifunction button.
- ▶ With the right rotary control ●, select either 0 or +15.



The GAL setting can be used to specify the starting point for the volume increase according to vehicle speed. The setting is stored automatically. The settings are:

- 0 - No volume increase
- +1 - Volume increase is initiated at low speed
- +15 - Volume increase is initiated at higher speed

Telephone mute function (Tel)

If a telephone with hands-free operation is installed, the call may be routed through the speaker system. This eliminates the need for an additional speaker. However, the signal leads (AF – Telephone input and Earth – Telephone input) must be connected to the car radio (see also page 98).

- ▶ To set, call up user menu.
- ▶ By pressing multifunction button **Tel**, select **Audio Sys.** or **Mute.**



- **Mute** - Telephone Mute setting
- **Audio Sys.** - Telephone conversation via car radio

Display brightness (Lum)

With this function, the brightness of the display can be set.

- ▶ To set, call up user menu.
- ▶ Press the **Lum** multifunction button.
- ▶ With the right rotary control ●, select either -8 (dark) or 8 (light).



The setting is stored automatically.

LED setting

This function can be used to switch the LED function (flashes when the unit is switched off) on and off.

- ▶ To set, call up user menu.
- ▶ By pressing multifunction button **Led** select either **blinking** (LED On) or **off** (LED Off).



The setting is stored automatically.

Setting reception optimisation (M/S)

In order to suppress reception-related interference, three different parameters can be set for reception optimisation.

- ▶ To set, call up user menu.
- ▶ By pressing multifunction button **M/S**, select from **Stereo**, **Mono** and **Auto**.



- **Auto** - Setting for normal operation, i.e. depending on reception, the unit switches back and forth from stereo to mono (offers the optimum setting for almost all reception areas).
- **Stereo** - Setting for exceptional reception conditions - i.e. the unit is constantly set to stereo.
- **Mono** - Setting for reception conditions in which reflections constantly occur - i.e., the unit is constantly set to mono.

The setting is effective immediately and is also retained after power is turned off.

User settings

AUX input (Aux)

This can be used to switch on the CD changer AF connections if no CD changer is connected. An external unit (Discman, Walkman, etc.) can then be connected.

- ▶ To set, call up user menu.
- ▶ With multifunction button **AUX**, select either **AUX Mode on** (On) or **AUX Mode off** (Off).



The setting is stored automatically.

In CD mode, multifunction button **AUX** must be pressed to select AUX mode.

Signal tone volume (BeV)

The volume of signal tones (e.g. storage confirmation) can be set using this function.

- ▶ To set, call up user menu.
- ▶ Press the **BeV** multifunction button. With the right rotary control ●, select between **0** (Low) or **+5** (Loud).



The setting is stored automatically.

Calling up / exiting service menu

The following information can be called up whilst in the Service menu:

- **Model -No.** : - Display of the model number
- **Serial -No.** : - Display of the serial number
- **Changer Reset** - Reset triggering for CDC
- **GAL** - Display of the current GAL adjustment
- **Radio Software** : - Displays radio software version
- **Radio Bolo** : - Display of radio Bolo status

- ▶ In radio mode, press **AM** button and the multifunction button **10** at the same time.



- ▶ The individual entries can be selected by pressing multifunction buttons **Nxt** and **Prv**, or by turning the right-hand rotary control ●.

To exit the Service menu, press multifunction button **End**.

CD Changer reset

It is possible to reset the CD-changer here if the CD-changer malfunctions.

- ▶ Requesting service menu.
- ▶ Press multifunction button **Nxt** repeatedly until **Changer Reset** is displayed.



- ▶ Press multifunction button **Res**.

Unit reset

If a malfunction of the unit should occur, such that it becomes inoperable or defective in some other way, a restart of the internal unit software (reset) can be triggered with the following button combination:

To trigger a reset, simultaneously press multifunction button **1**, multifunction button **3** and the **TP** button.

Installation and removal instructions

A universal bracket for DIN installation slots is integrated into this car radio. An installation frame is not required. The unit is inserted into the installation slot and secured with the slides supplied.

To install, complete all electrical connections. Then push the unit into the installation slot. Afterwards, insert slides into the openings on the front of the unit until the first detent position is reached (Figure A). Now lock the radio by pulling both slides, as shown in Figure B. Subsequently, remove the slides.

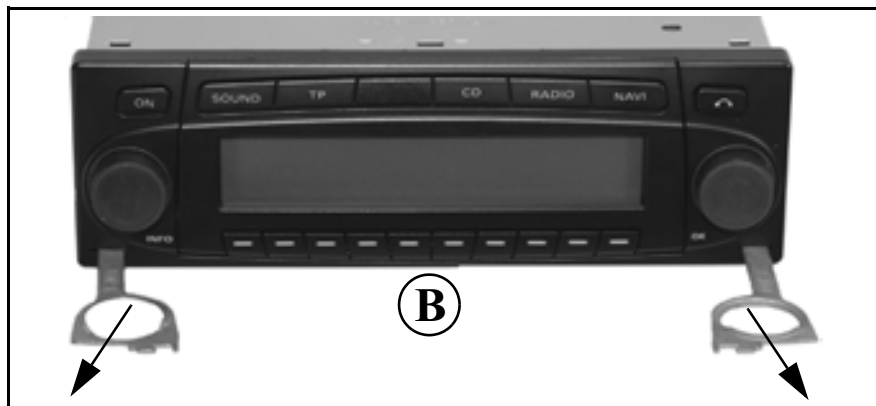

Installation and removal instructions

To remove the unit, it must first be unlocked. To do this, push in both slides to the second detent position as shown in Figure A. Subsequently, withdraw the unit using both slides (Figure C). Then remove the slides by pressing the springs on the right and left sides of the unit.

If the unit was previously installed in another vehicle, it may be necessary to adjust the springs on the unit before installation. To adjust the springs, insert slide as shown in Figure D and afterwards adjust as shown in Figure E (gently press slide in the direction of “1”, whilst at the same time moving the slide in the direction of “2” or “3”).

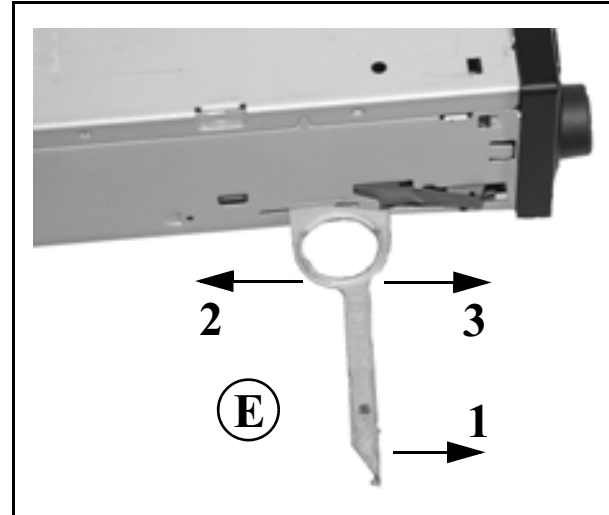
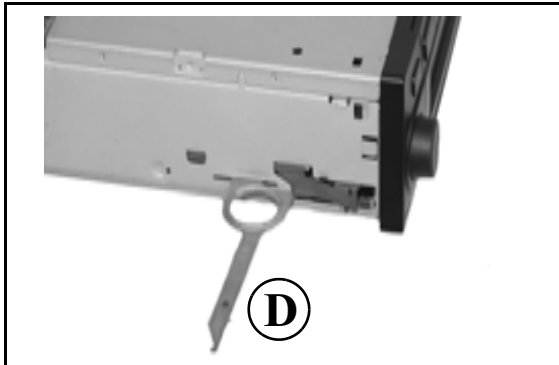
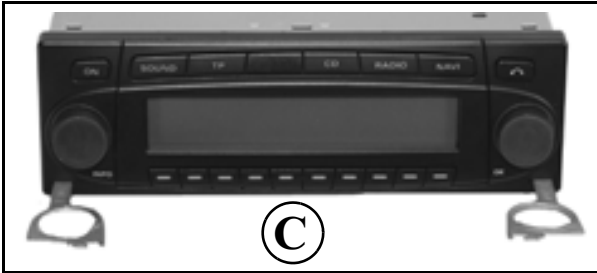

Connection instructions

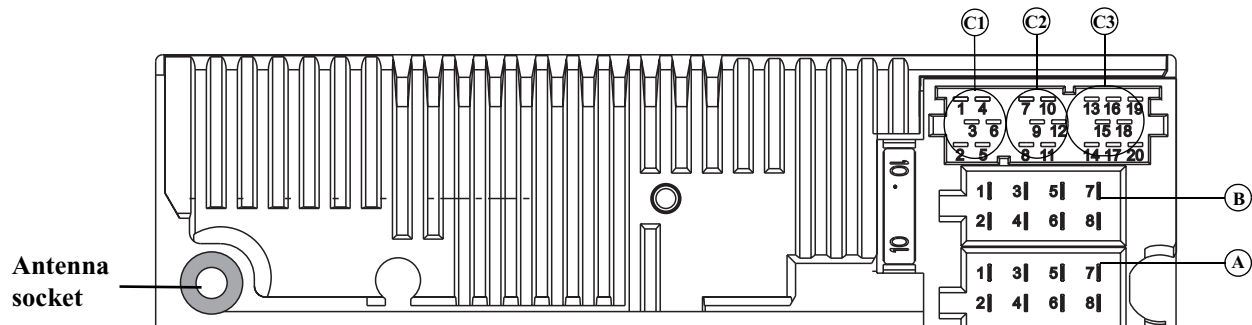

Warning. Terminal 30 and Terminal 15 must always be connected separately, otherwise increased power consumption will occur when the unit is switched off. Connection socket A is not the same for all vehicle types. Therefore, always measure voltages before installation.

Socket A

- 1 Speed Signal (GAL)
- 2 Not assigned
- 3 Telephone mute / clearing function
- 4 Permanent positive (Terminal 30)
- 5 Control output for automatic antenna / amplifier
- 6 Illumination (Terminal 58)
- 7 Switched positive (Terminal 15)
- 8 Earth (Terminal 31)

Socket B

- 1 Loudspeaker right rear +
- 2 Loudspeaker right rear -
- 3 Loudspeaker right front +
- 4 Loudspeaker right front -
- 5 Loudspeaker left front +

- 6 Loudspeaker left front -
- 7 Loudspeaker left rear +
- 8 Loudspeaker left rear -

Socket C1

- 1 LineOut left rear
- 2 LineOut right rear
- 3 AF Earth
- 4 LineOut left front
- 5 LineOut right front
- 6 Subwoofer LineOut

Socket C2

- 7-12 Specific connection for Becker CD changer

Socket C3

- 13 AF – telephone input
- 14 Earth – telephone input
- 15-17 Specific connection for Becker CD changer
- 18 CD AF earth (AUX)
- 19 CD AF left (AUX)
- 20 CD AF right (AUX)

RDS SYSTEM

This car radio is capable of receiving RDS signals (RDS = Radio Data System) on the VHF bands. RDS is a technique for the transmission of inaudible information in the VHF broadcasting range. This means that the broadcaster sends information to be analysed by the car radio.

DAS Seek Qual. level

At the level **DAS Seek Qual.**, all receivable and identifiable RDS programmes are stored in a list sorted by quality. The dynamic autostore, search and scan search functions access this list.

DAS Seek Name level

At the level **DAS Seek Name** all receivable and identifiable RDS programmes are stored in a list sorted alphabetically by name. The dynamic autostore, search and scan search functions access this list.

RDS Stations level

At the level **Stations RDS** only identified RDS stations can be stored. The unit constantly switches to the best receivable transmission frequency for the station. During search for **Stations RDS** the unit will stop only at identifiable stations.

Stations Fix level

At the level **Stations Fix** frequencies can be assigned to the station buttons. RDS evaluation does not take place. The search for **Stations Fix** is equivalent to manual FM tuning (Page 63).

PTY (programme type)

With the PTY function, it is possible to select specific types of programmes, such as sport, pop music, classical music etc.

The PTY is broadcast by the RDS station, provided that the broadcaster has this function installed. The selected station programme type can be displayed or a search for a specific PTY station can be performed.

Examples of programme types are:

NEWS	News services
POP M	Pop music
AFFAIRS	Politics and current affairs
ROCK M	Rock music
INFO	Special talk programmes
SCIENCE	Science

Explanations

EDUCATE	Education
LIGHT M	Light music
DRAMA	Radio plays and literature
CLASSICS	Classical music
CULTURE	Culture, church, society
EASY M	Musical entertainment
VARIED	Light entertainment
SPORT	Sport
OTHER M	Special music programmes
WEATHER	Weather report
FINANCE	Financial information
CHILDPRG	Children's programmes
SOCIAL	Social reports
RELIGION	Religious reports
PHONE IN	Interviews
TRAVEL	Travel reports
LEISURE	Leisure time reports
JAZZ	Jazz music
COUNTRY	Country music
NATION M	National folk music
OLDIES	Oldies
FOLK	Folk music
DOCUMENT	Documentation
NO PTY	No PTY

Autostore

With this function, the stations with the strongest signals are stored in the autostore memory, sorted by reception quality.

AUX

(Auxiliary)

Connection for external audio signals.

Balance

Volume setting between left and right loudspeakers.

CDC

(Compact Disc Changer)

CD-changer

CD-R

(Compact Disc Recordable)
write-once CD.

CD-RW

(Compact Disc ReWritable)
rewritable CD.

Code number

A secret number that must be entered to activate the unit.

Fader

Volume setting between front and rear loudspeakers.

Folder

Directory

Folder on a CD that contains MP3 or WMA tracks.

GAL

(Speed-dependent volume control)

At high vehicle speeds, the volume is increased

ID3-Tag

“Contents” of an MP3 track. Contains information such as track, artists, album, year and genre.

Loudness

By increasing the treble and bass sounds, provides a better sound for low volumes.

M3U

Format for playlists supported by unit.

MP3

Special process for compressing audio data (e.g. music).

Playlist

A file that is stored on a CD together with MP3 files. It specifies the play sequence.

PLS

Format for playlists supported by unit.

PTY identification

(Programme Type identification)

Identification of the programme transmitted by a station.

Radio text

Additional information that is transmitted by some VHF broadcasters via RDS.

Technical terminology glossary

RDS

(Radio Data System)

A process for transmission of inaudible information on the VHF band.

Regionalisation

Regional identification contained in RDS. Station transmits regional programme.

Reset

Reset the system to factory defaults.

Scan search

Plays receivable radio stations or CD tracks in succession for a short time.

TA

Traffic Announcement

TP

(Traffic Programme)

Identification for traffic programme broadcasters.

WMA

(Windows Media Audio)

Special compression process developed by Microsoft[®] for compressing audio data (i.e. music).

A		D		I	
Assigning CD names	.82	DAS	.60	ID3 tag	.74
Autostore	.69	Display brightness	.85	L	
AUX	.86	Dynamic autostore	.60	LED	.85
B		F		Loudness	.59
Balance	.59	Fader	.59	M	
Bass	.58	Fader control	.59	M3U	.75
Brightness	.85	Fast forward		Manual tuning	
C		CD	.71	AM	.69
CD		MP3/WMA	.78	FM	.63
Ejecting	.70	Fast reverse		MP3	.74, 76
Inserting	.70	CD	.71	Mute function	
Notes	.70	MP3/WMA	.78	Telephone	.67, 84
CD changer	.80	Filter		Traffic programme	.67
CDC	.80	CDC	.83		
CD-R	.73	Radio	.61		
CD-RW	.73	FM reception optimisation	.85		
Control component		Folder	.77		
Inserting	.57	Frequency display	.64		
Removing	.57	G			
Copy protection	.73	GAL	.84		

Index

P

Playlist	75, 77
M3U	75
PLS	75
PLS	75
Portable panel	
Inserting	57
Removing	57
Program type	62
Programme filter	61
PTY	62

R

Radio menu mode	60, 68
Radio mode	60, 68
Radio text	64
Random play	
CD	72
MP3/WMA	78
Regional programme	63
Regionalisation	63
Repeat	
CD	71
MP3/WMA	78

S

Scan	
CD	71
MP3/WMA	77
Radio	61, 68
Scan search	
CD	71
MP3/WMA	77
Radio	61, 68
Signal tone	86
Sound setting	58
Speed-dependent volume	84
Station	
Request	62
Storing	62
Station memory	
AM	69
FM	62
Station search	
FM	61
MW, LW, SW	68
Subwoofer	59
Switching off	58
Switching on	58

T

Temperature protection circuit	73
Tone menu	58
TP	65
Announcement volume	67
Interruption of announcement	67
Menu	65
Switching off	65
Switching on	65
Track change	
CD	71
MP3/WMA	77
Track filter	83
Track repeat	
CD	71
MP3/WMA	78
Track skip	
CD	71
MP3/WMA	77
Traffic Programme	65
Traffic programme	65
Announcement volume	67
Interruption of announcement	67
Menu	65
Mute	67
Mute function	67
Switching off	65
Switching on	65

Treble	58
Tuning steps	69

V

Volume

Signal tone	86
Speed-dependent	84
Subwoofer	59
TP announcement	67
Unit	58

W

Waveband

AM	68
FM	60
WMA	74

Technical data

- **Wavebands:**
 - FM 87.5 MHz - 108 MHz
 - MW 531 kHz - 1620 kHz
 - LW 153 kHz - 282 kHz
 - SW 5800 kHz - 6250 kHz
- **Frequency range:**
 - 20 Hz - 20 kHz for CD-mode
 - 30 Hz - 15 kHz for FM
 - 50 Hz - 2.5 kHz for MW, LW, SW
- **Output:**
 - 4 x 18 Watt
- **Line cross section:**
 - 0.75 mm² min.
- **Loudspeaker impedance:**
 - min. 4 Ω
- **Line out:**
 - 4 x analog Line Out (V_a max 3V_{eff} at 10 kΩ)
- **GAL:**

In order to utilise the GAL, a square wave voltage with a mass-related amplitude of +4 V to +12 V must be provided by the vehicle's electronic speedometer. Volume is increased in 7 increments of 2.5dB each.
- **Antenna:**
 - Impedance 50 Ω
- **AF telephone input:**
 - Max. input voltage 8 V (if interference occurs, a commercially available 1 : 1 repeater should be connected into the signal cable).
- **AUX input:**
 - 16 KΩ Input resistance, max. input voltage 1.7 V_{eff}
- **Telephone mute:**
 - Low active level < 2 Volt
- **Supply voltage:**
 - 12 Volt
- **CD Connection:**
 - Becker Silverstone 2630, Silverstone 2660 and Silverstone 7860 CD changers can be connected.
- **Playable CDs:**
 - Only CDs which comply with DIN EN 60908 can be used. The use of 8 cm CDs with an adapter is not recommended

NOTICE

Dear Listener,

In conformance with current EC guidelines, any person may operate this radio receiver. This unit conforms to the current valid European or harmonised national standards. This designation is your guarantee that the unit conforms to the applicable specifications regarding electromagnetic compatibility. This means that interference with other electrical/electronic devices caused by the unit, or interference with this unit caused by other electrical/electronic devices is largely prevented.

The EC type-approval mark (e1) issued by the Federal Office for Transport (KBA) in accordance with European Directive 95/54/EC governing the EMC of motor vehicles authorises installation and operation of the unit in motor vehicles (classes M, N and O).

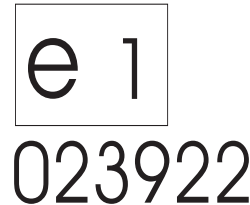

With regard to the following European standards, the EMC requirements that apply specifically to this unit have been met:

- EN 55013
- EN 55020